

Schematic	control_driver_board		Update Date	2023-08-04
			Create Date	2023-08-04
Page	motor_driver		Part Number	
Drawn	DoubleHan	control_driver_board_V6.0		
Reviewed				
		VER	SIZE	PAGE 2 OF 4
		V1.2	A4	Tsinghua TEA Lab

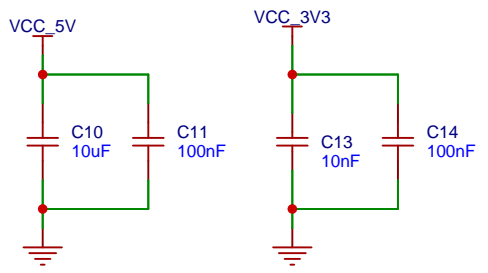

Strictly isolated!

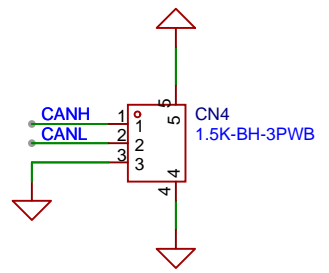
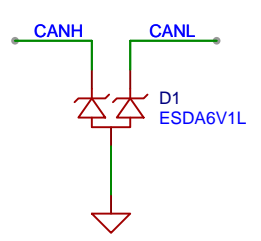
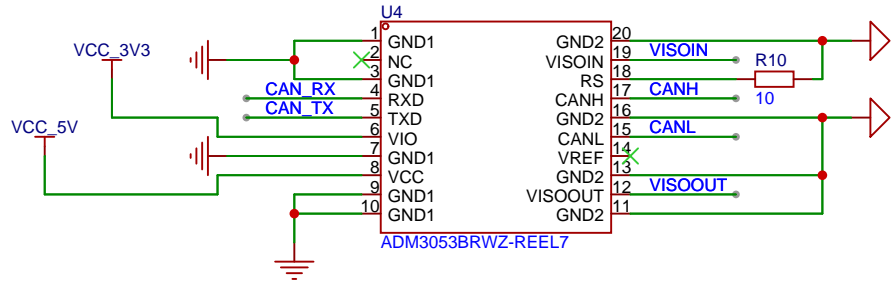
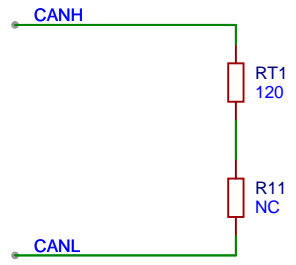
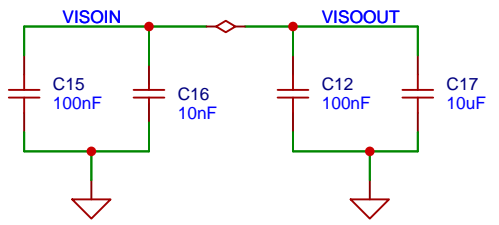

Schematic	control_driver_board		Update Date	2023-08-04
			Create Date	2023-08-04
Page	can_isolated_transceiverver		Part Number	
Drawn	DoubleHan		control_driver_board_V6.0	
Reviewed				
	VER	SIZE	PAGE	3 OF 4
		V1.2	A4	Tsinghua TEA Lab

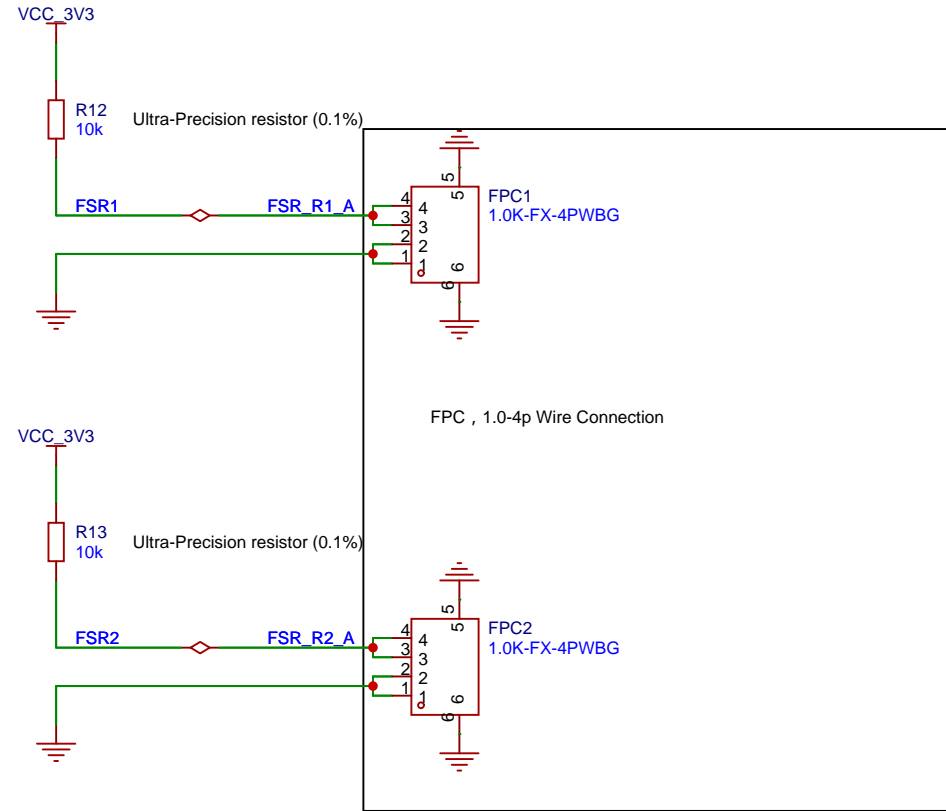

Schematic	control_driver_board		Update Date	2023-08-04
Page	FSR		Create Date	2023-08-04
Drawn	DoubleHan	control_driver_board_V6.0		
Reviewed				
		VER	SIZE	PAGE 4 OF 4
		V1.2	A4	Tsinghua TEA Lab